

CONDOR

Automatic Key Cutting Machine
XC-MINI

User Manual

V.2.0

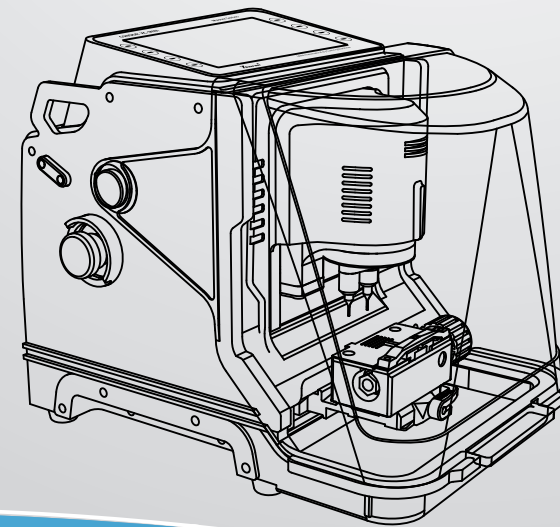

TABLE OF CONTENTS



XC-MINI
Automatic Key Cutting Machine

1 SAFETY PRECAUTIONS AND WARNINGS	02
2 GENERAL INFORMATION	03
3 PRODUCT PACKAGING CHECKLIST	04
4 OVERVIEW	
4.1 SCHEMATIC	06
4.2 CHARACTERISTICS	07
4.3 SPECIFICATIONS	07
5 MACHINE INSTALLATION AND PREPARATION	
5.1 INSTALLING THE CUTTER	08
5.2 REMOVING THE CUTTER	09
5.3 CLAMP INSTALLATION	10
5.4 CLAMP SAMPLES	11
6 OPERATING INSTRUCTIONS	
6.1 HEIGHT LEVEL ADJUSTMENT	12
6.2 CLAMP CALIBRATION	14
6.3 CUTTING CALIBRATION	17
6.4 HOW TO USE KEY DATABASE	19
6.5 HOW TO USE KEY DUPLICATION	22
6.6 HOW TO USE CUT BY BITTING	25
6.7 HOW TO USE FIND BITTING	29
7 ONLINE UPDATE	32
8 HOW TO USE CUSTOMIZE TOOL	34

1 . Safety Precautions and Warnings

To prevent personal injury or machine damage, users should carefully observe the instructions provided by this operation manual and adopt the following safety precautions:

- Always operate the machine under the safe condition.
- Wear safety glasses that meets ANSI standards.
- Keep protective shield closed when machine is operating.
- Keep clothing, hair, hands, tools, test equipment, etc. away from all moving parts.
- Do NOT leave the machine while it is operating.
- Do not use damaged or loosen power cord and power outlet.
- Unplug the power cord when not in use for a long time.
- Do not place the machine in any wet, oily, dusty area.
- Do not place any tool or container on the machine.
- Place the machine on a horizontal surface, which should be firm enough to carry the weight of the machine.
- Keep the machine clean and dry.
- Shut down the machine immediately when any exception occurs.

2 . General Information

Thank you for choosing CONDOR XC-MINI Automatic Key Cutting Machine. This manual serves as a guide for users of CONDOR XC-Mini Automatic Key Cutting Machine. Please read it carefully before use. It is crucially important if you wish to operate the machine safely and efficiently.

- If exterior color of the machine changes, the final Color in kind prevail
- Under the usage of instruction sheet, The warranty time is three year
- Even if within the warranty period, if the following occurs, certain maintenance costs will not be free:

- The product malfunction caused by Not in accordance with the user manual operation.
- The malfunction and damage caused by unauthorized repairs and alteration.
- The product malfunction caused by the fall, crash and the improperly voltage.
- Damage due to force majeure.
- Long time use in harsh places or vehicles, ships equipped with caused by failure or damage.
- The working condition caused pollution and old, will not replace the shell.

All rights reserved. No part of this publication may be reproduced, stored in a retrieval system, or transmitted, in any form, or by any means (mechanical, electronic, photocopying, recording, or others), without permission of XHorse. Due to continuous product improvement, the information contained in this manual is subject to change without notice.

3 . Product Packaging Checklist

The whole package covers the following items, if missing, please contact your dealer.

Name	Image	Quantity	Description
2.5mmCutter		1	Cutting tool ($\text{Ø}2.5 \times \text{Ø}6 \times 40\text{L}$)
1.5mmCutter		1	Cutting tool ($\text{Ø}1.5 \times \text{Ø}6 \times 40\text{L}$)
1.0mm Probe		2	Detection tool ($\text{Ø}1.0 \times \text{Ø}6 \times 40\text{L}$)
2mm Allen wrench		1	Tool for tracer point installation
Power cord (1.5m)		1	Connect to power (Chinese Standard)
Power cord (1.5m) (optional)		1	Connect to power (British Standard)
Power cord (1.5m) (optional)		1	Connect to power (American Standard)
Power cord (1.5m) (optional)		1	Connect to power (European standard)
USB cable (2.0m)		1	Connect machine to PC

Brush		1	Tool for cleaning the machine
M1 Clamp		1	For Single/Double Sided Keys
M2 Clamp		1	For Channel-Track Keys
M3 Clamp (optional)			For Ford FO21 & Citroen SX9 Keys
KeyMachine body		1	Main body
Quality certificate		1	
Product Packaging Checklist		1	
User Manual		1	

Attention:

- Replace the cutter regularly to ensure the key cutting quality.
- Users should check the stepper motor belt regularly. If excessive wear and tear occur, please replace these parts to ensure the key cutting accuracy and the efficient operation of the machine.
- Please use the 10A fuse.

4 . Overview

4.1 Schematic



4.2 Characteristics

- Built-in Database
- Multi-languages Support
- 7" Capacitive Touch Screen
- 3-Axis Precision Ball Screw Transmission
- Cross Rail
- All Aluminum Machine Body
- Single machine with both Tracer/Cutter
- Standardly include two clamps M1/M2
- Software supports online-update
- Support Sided/Track/Dimple/Tibbe keys*

*Some Dimple/Tibbe keys need M3 optional clamps

4.3 Specifications

Input Voltage	90V--264VAC
Input Frequency	47~63Hz
Consume	200W
Packing Dimensions	L450×W450×H350mm
Machine Dimensions	L265×W362×H301mm
Display	1024×600
Spindle Speeds	9000rpm
USB	USB2.0
Working Temperature	0~50°C
Humidity	10~90%
Net Weight	18Kg
Gross Weight	22.9Kg

5 . Installation

5.1 Installing the cutter

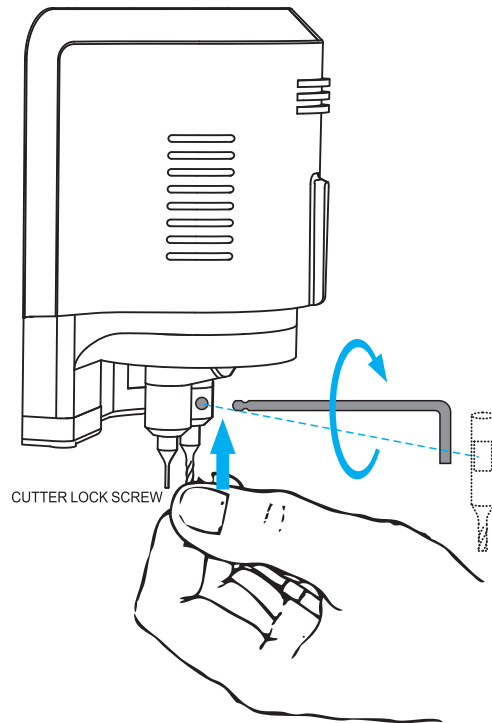

To Install the cutter

- 1) Put the cutter into the cutter hole and to the top limit position, ensure the section of cutter and clamp lateral parallel.
- 2) Turn the CUTTER LOCK SCREW clockwise, till the cutter is tightened.

5.2 Removing the Cutter

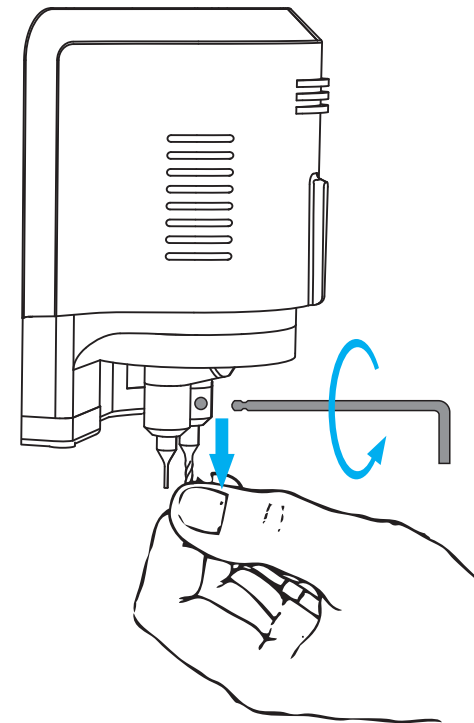

To Remove the Cutter

- 1) Hold the cutter lightly, Turn the CUTTER LOCK SCREW counter clockwise.
- 2) After the cutter loosen, remove it.

5.3 Clamp installation

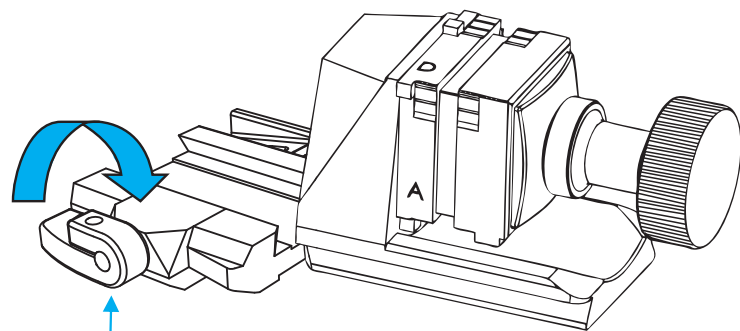

LOCKING WRENCH

To Install the Clamp

- 1) Turn the LOCKING WRENCH counterclockwise on the left side to loosen.
- 2) Choose the clamp according to the key type, Push the clamp from the right side of the CLAMP CARRIAGE to limit position
- 3) Turn the LOCKING WRENCH clockwise to tighten the clamp

5.4 Clamp Samples



Clamp M1

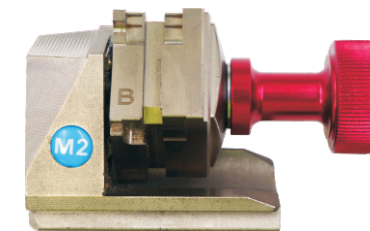

Clamp M2

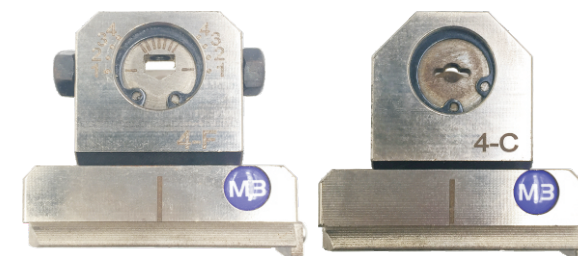

Clamp M3

6. Operating instructions

Please initial device before use :

6.1 Height Level Adjustment



1) Enter the Main interface, Click on the Self Test

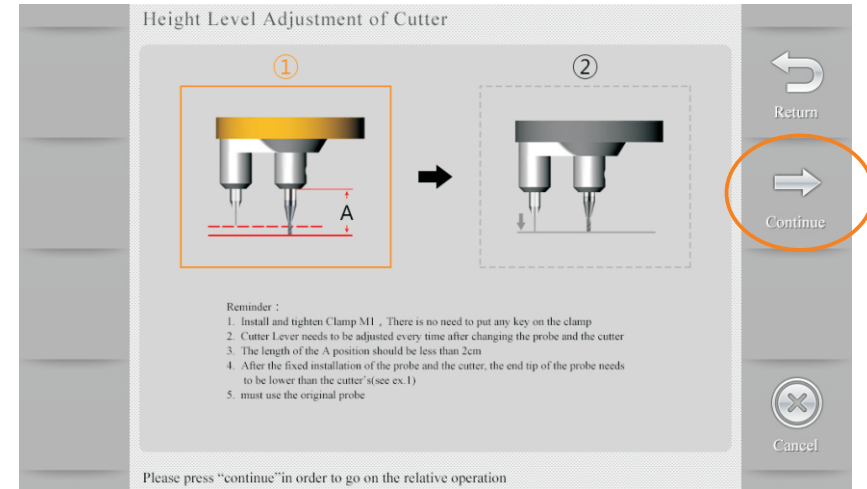

3) Follow the instructions on the screen, then click on the CONTINUE

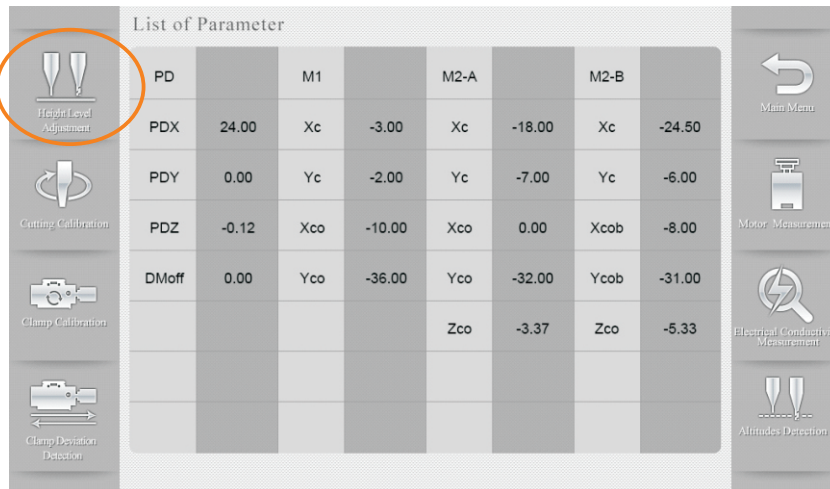

2) Click on Height Level Adjustment

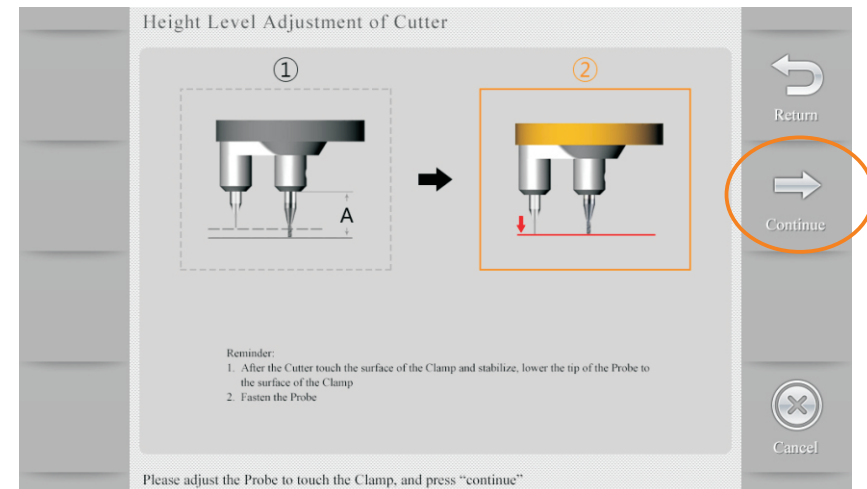

4) After the machine has stopped, follow the instructions on the screen till the tips of the probe and the cutter are on the same horizontal level. Then click on CONTINUE. The machine enters the Calibration Process.

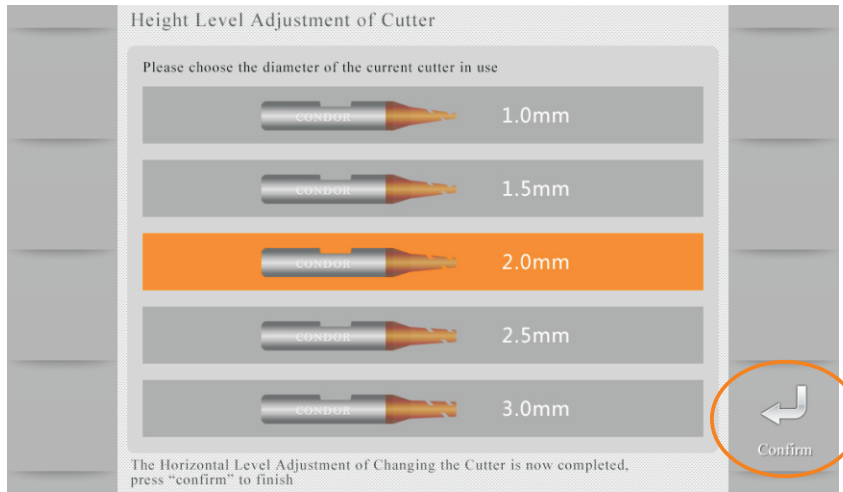

5) After the machine has stopped, select the diameter of the current cutter in use, then click on Confirm to finish

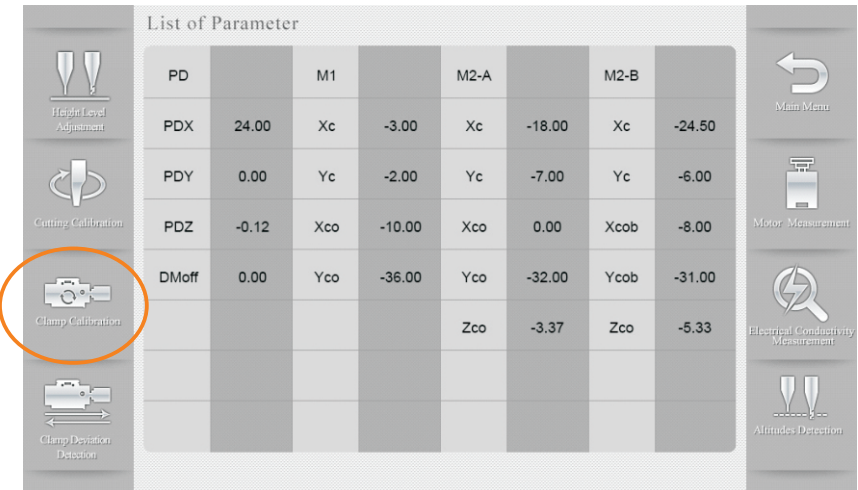

2) Enter Self Test interface, Click on Clamp Calibration

6.2 Clamp Calibration



1) Enter the Main interface, Click on Self Test

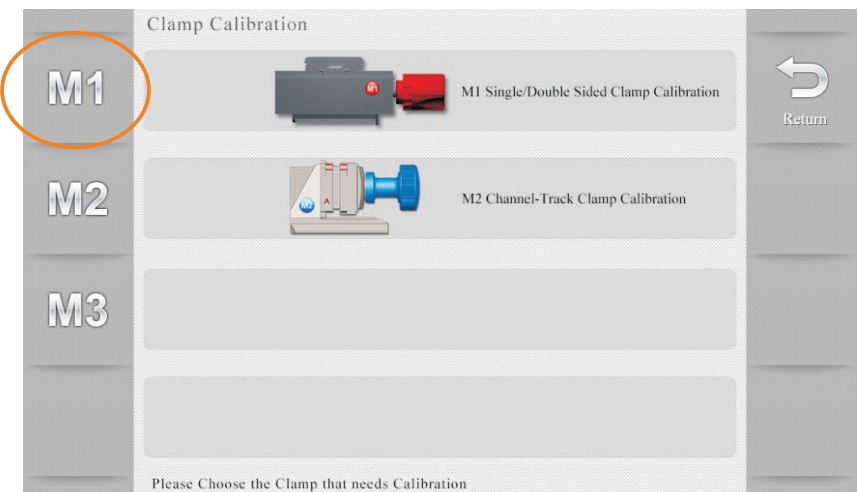

3) Enter Clamp Calibration, Click on M1 button

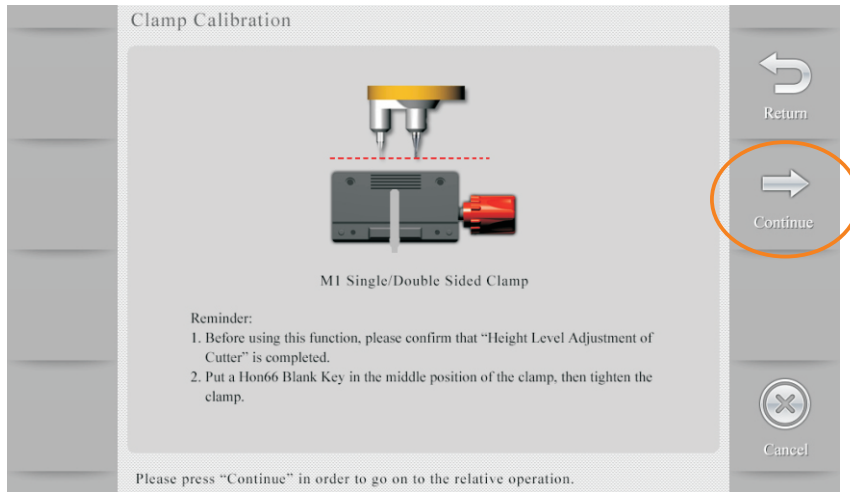

4) Follow the steps on the screen, then click on Continue,complete M1 Clamp Calibration.

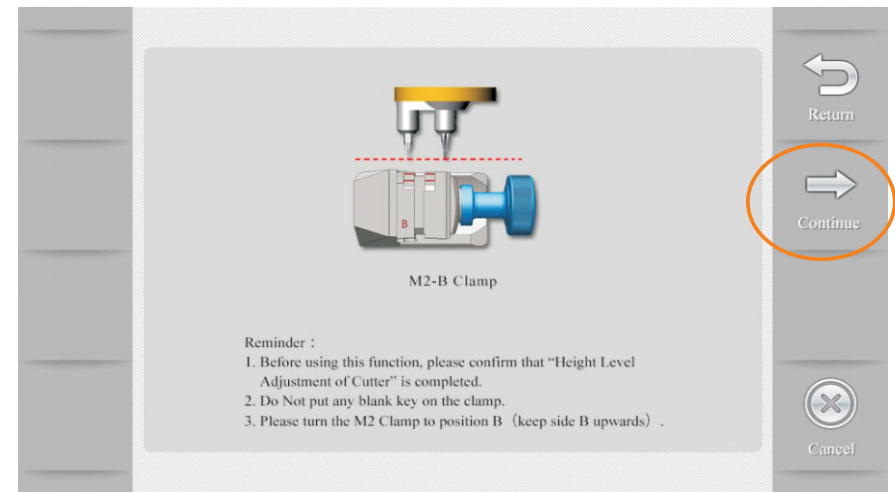

6) Turn clamp to SideBCD,and calibrate each side, do all steps follow the screen, complete M2 Clamp Calibration.

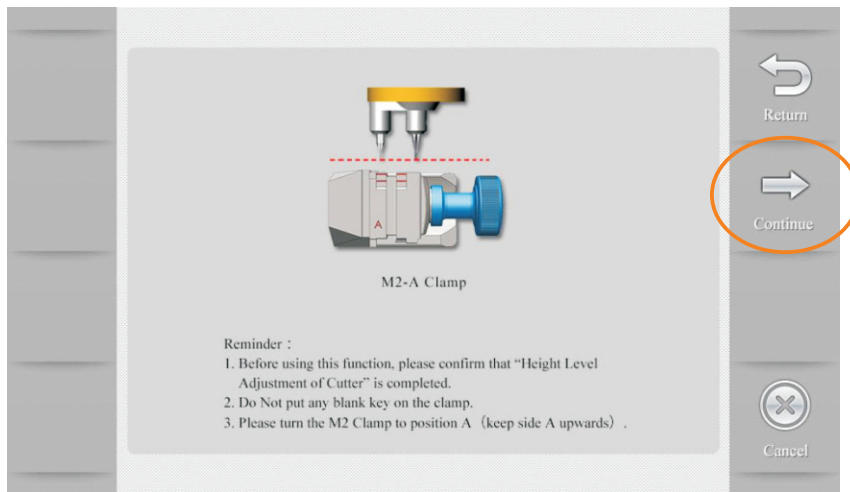

5) Enter M2 Clamp Calibration,Do Not put any key blank on the clamp,keep Side A upwards,then click on Continue

6.3 Cutting Calibration



1) Enter the Main interface, Click on Self Test

List of Parameter								
PD		M1		M2-A		M2-B		
PDX	24.00	Xc	-3.00	Xc	-18.00	Xc	-24.50	
PDY	0.00	Yc	-2.00	Yc	-7.00	Yc	-6.00	
PDZ	-0.12	Xco	-10.00	Xco	0.00	Xcob	-8.00	
DMoff	0.00	Yco	-36.00	Yco	-32.00	Ycob	-31.00	
				Zco	-3.37	Zco	-5.33	

2) Enter Self Test interface, Click on Cutting Calibration

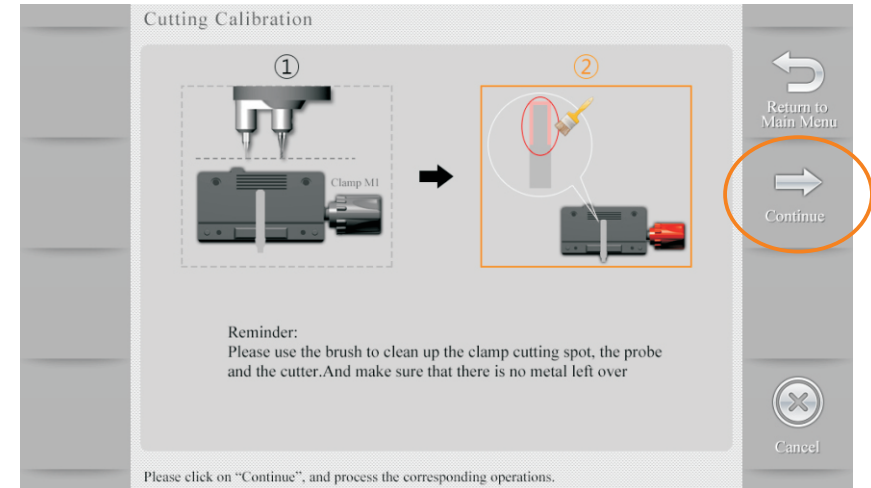

4) Please use the brush to clean up the clamp cutting spot, the probe and the cutter. then click on CONTINUE, Cutter Calibration Complete

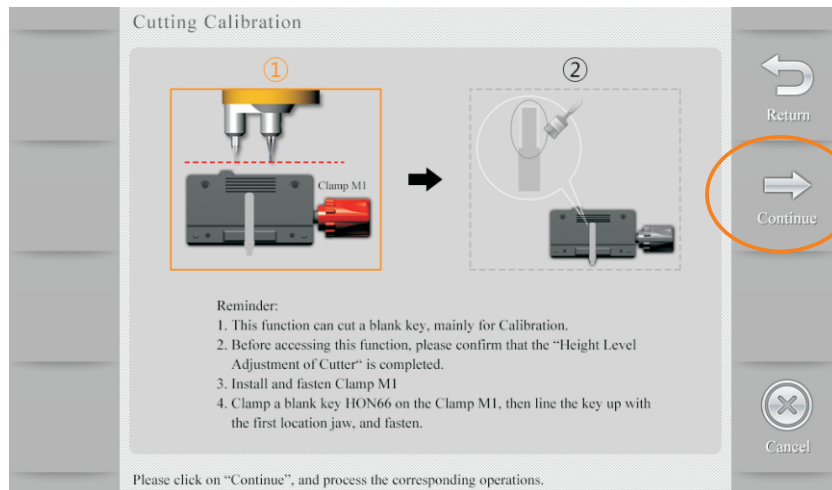

3) Follow the steps on the screen, then click on CONTINUE, The Cutting Calibration in Process

6.4 How to use "Key Database"

User need to supply the key code, then can cutting the key.



1) Enter the Main interface, Click on Key Database

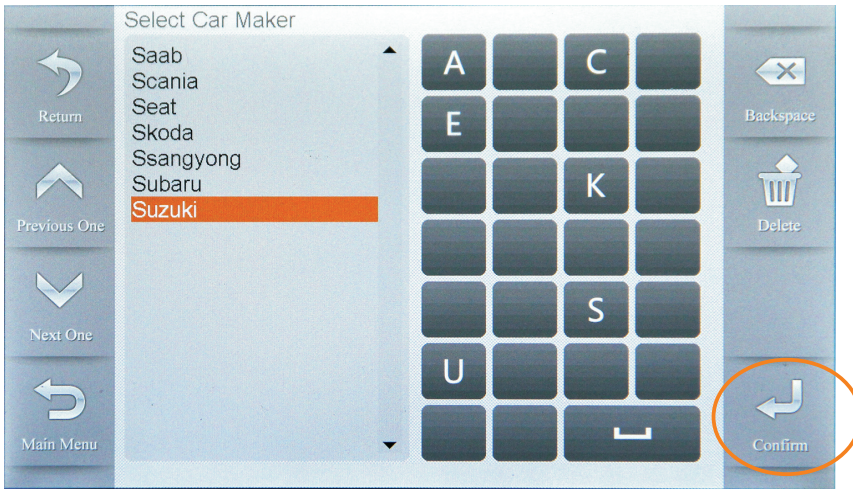

2) Choose the Car Brand, Click on Confirm

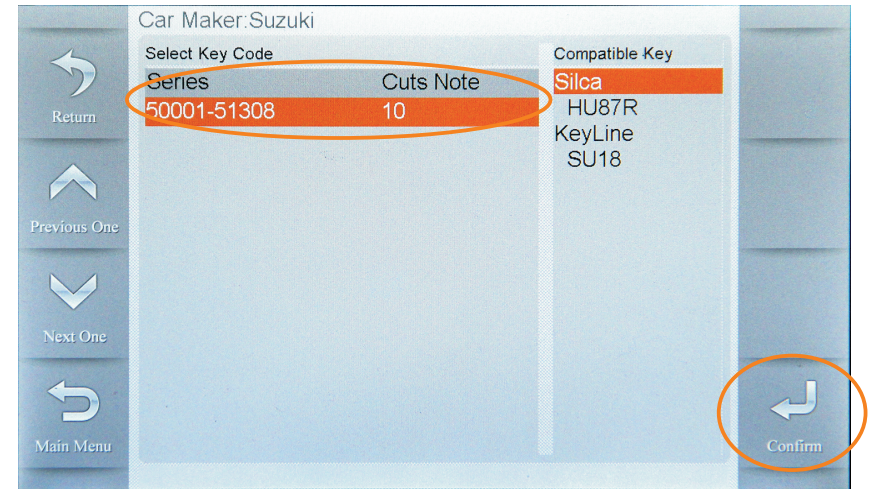

4) ①Enter the key serial cod ②Click on Confirm

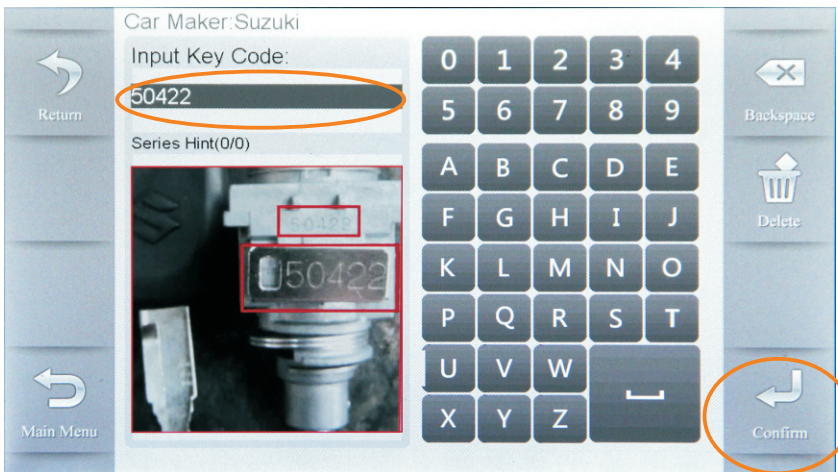

3) ①Enter the key code ②Click on Comfirm

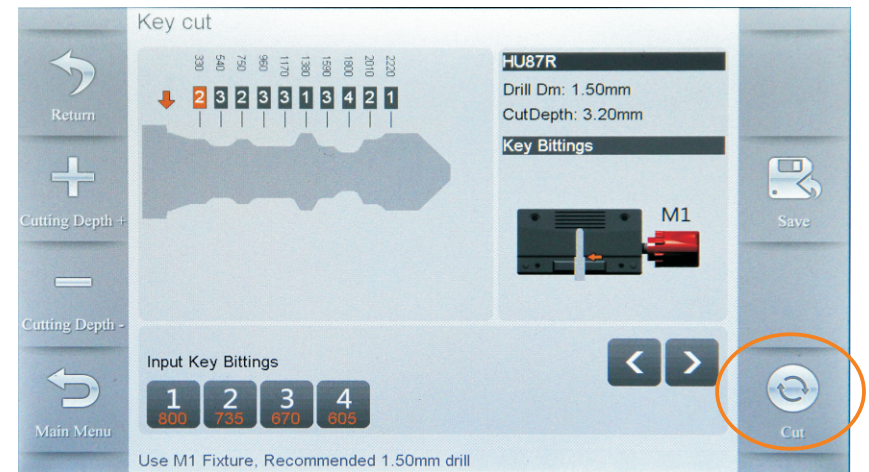

5) The Bitting Code will be found in the database, and it will be shown on the screen, Click on Cut to start

6.5 How to use "Key Duplication"

User need to supply the Car type and Year of the production



1) Enter the Main interface, Click on Key Duplication

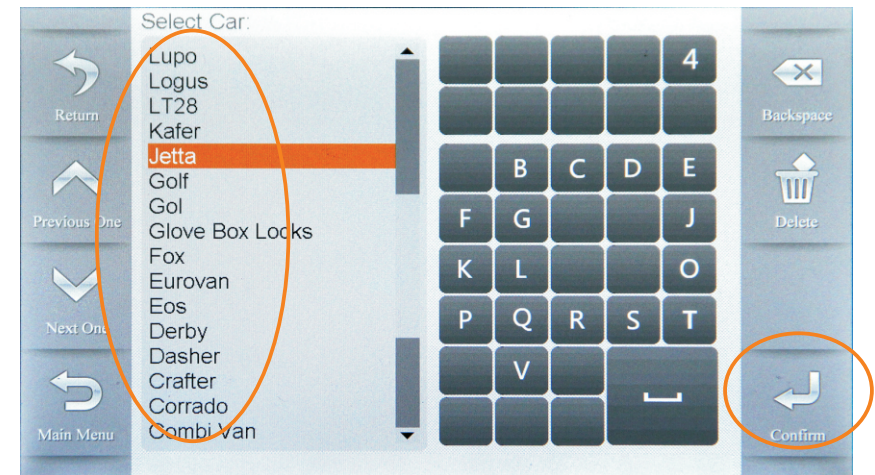

3) Choose Car Type, Click on Confirm

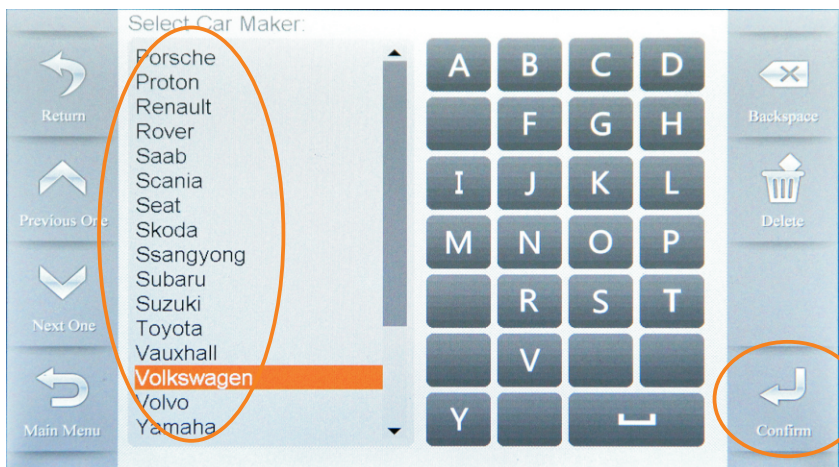

2) ①Choose the Car Maker ②Click on Confirm

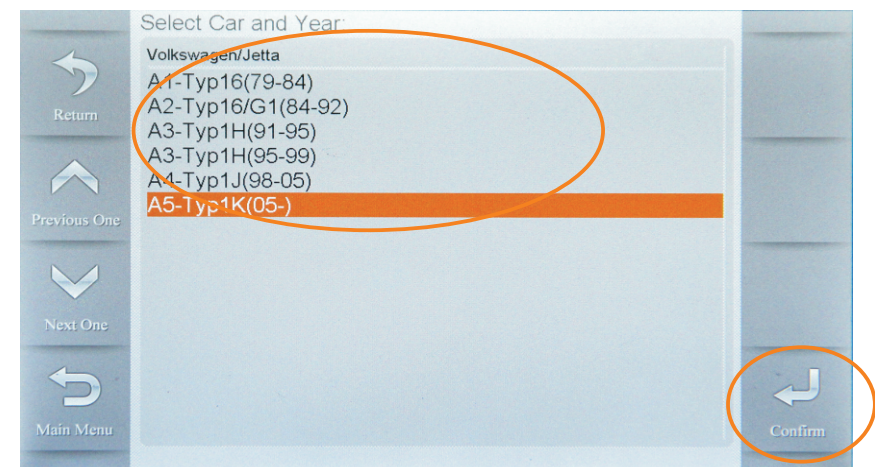

4) Choose the Car type and Year of the production, Click on Confirm

6.6 How to use "Cut by Bitting"

There are 2 methods to get the key using Cut by Bitting
 Method 1: without the origin key using Cut by Bitting



5) Put the original Key in the properly position of the clamp display on the screen, then Click on Decode Key



1) Enter the Main interface, Click on Cut by Bitting

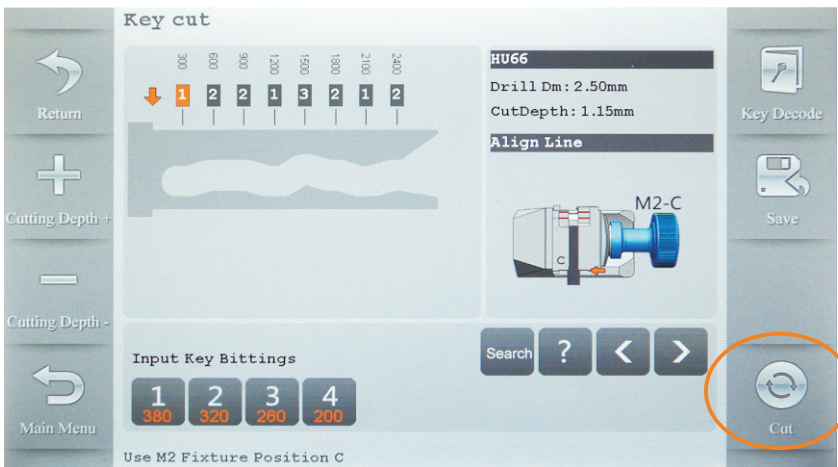

6) Verify bit code and modify bit code if needed, Click on Cut to start

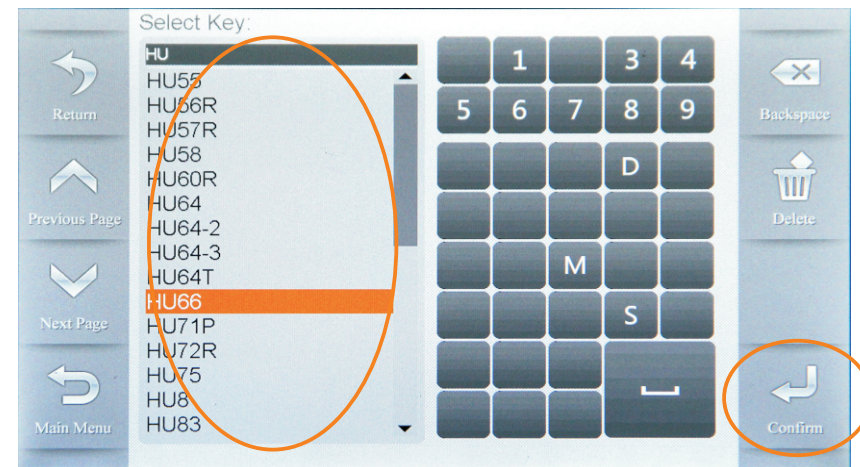

2) Choose the Blank Key, Click on Confirm

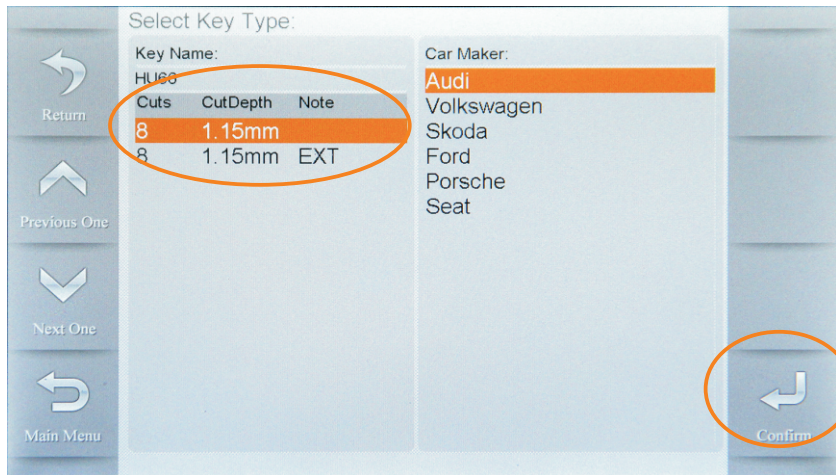

3) ①Select Key Type ②Click on Confirm

Method 2 : existing the origin key using Cut by Bitting

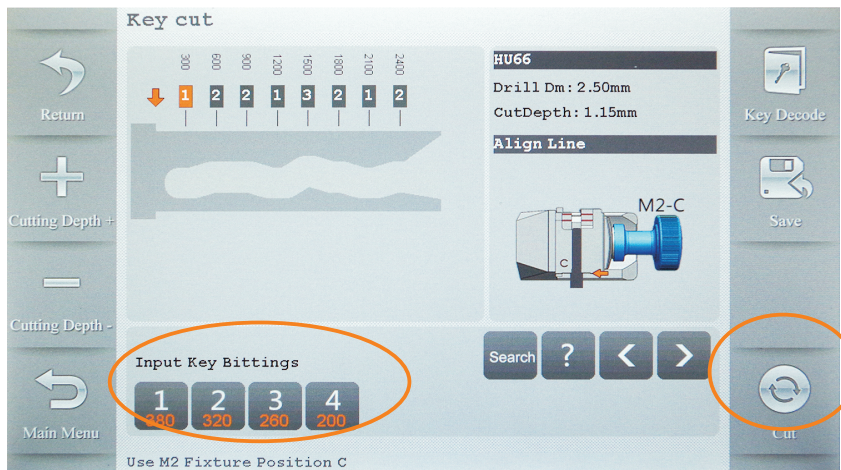

1) Choose the Blank Key, Click on Confirm

4) ①Put the Blank Key in the properly position of the clamp display on the screen
②Enter bitting and verify, then click on Cut to start

2) Select Key Type, Click on Confirm

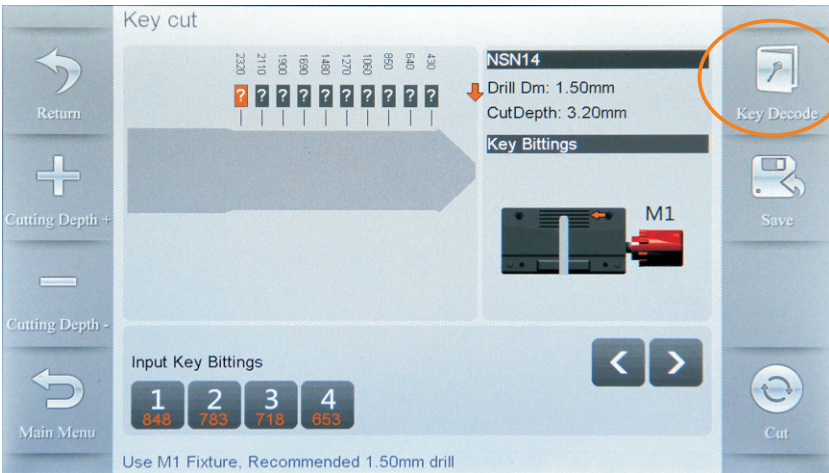

6.7 How to use "Find Bitting"

Parts of the car are missing bitting on door lock/trunk lock/ignition lock, enter unknown bitting as "?"



3) Click on Decode Key, the found bitting will display on the screen

1) Enter the Main interface, Click on Find Bitting

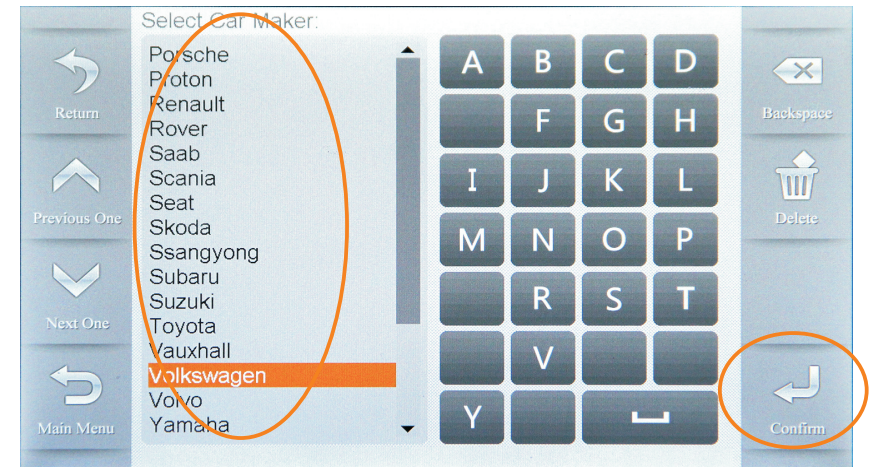

4) Verify bitting and modify bitting if needed, Click on Cut to start

2) ①Select Car Maker ②Click on Confirm

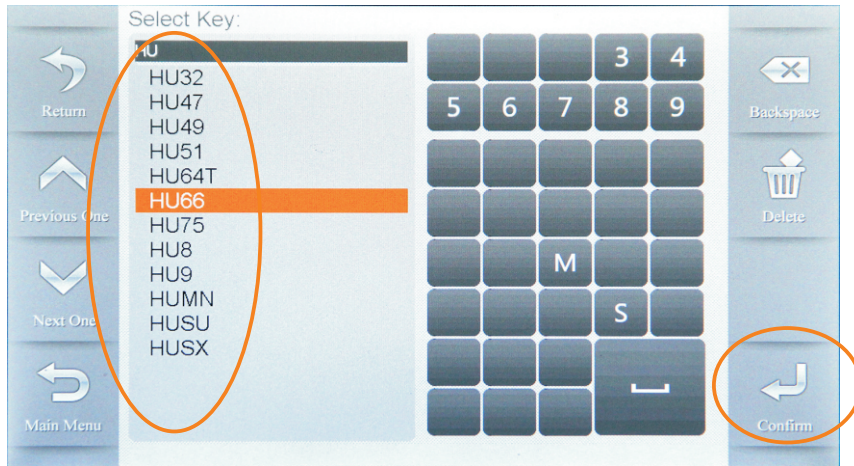

3) ①Select the Blank Key ②Click on Confirm.

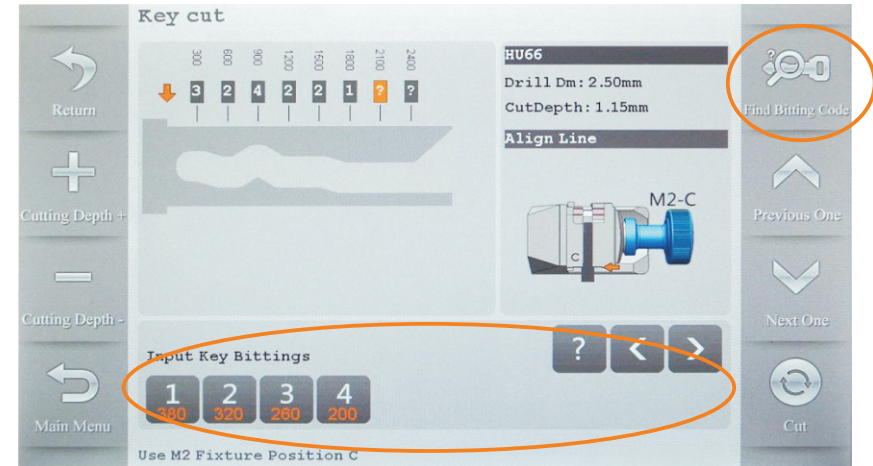

5) ①Enter known bitting
②Enter unknown bitting as "?"
③Click on Find Bitting Code

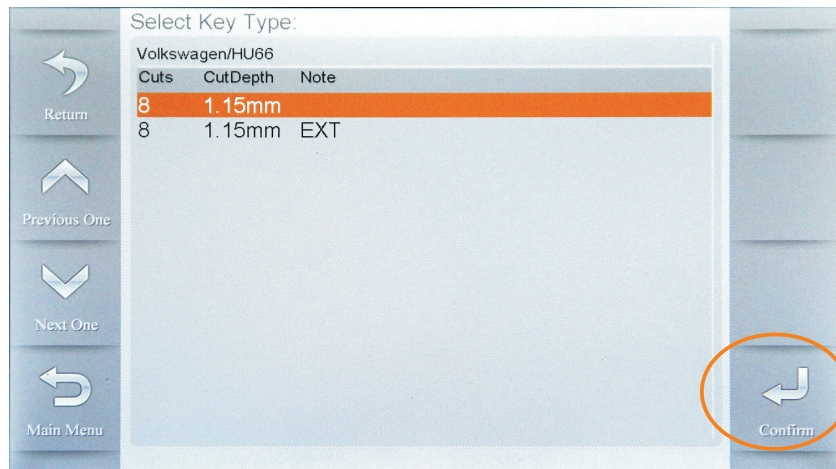

4) ①Select Key Type ②Click on Confirm

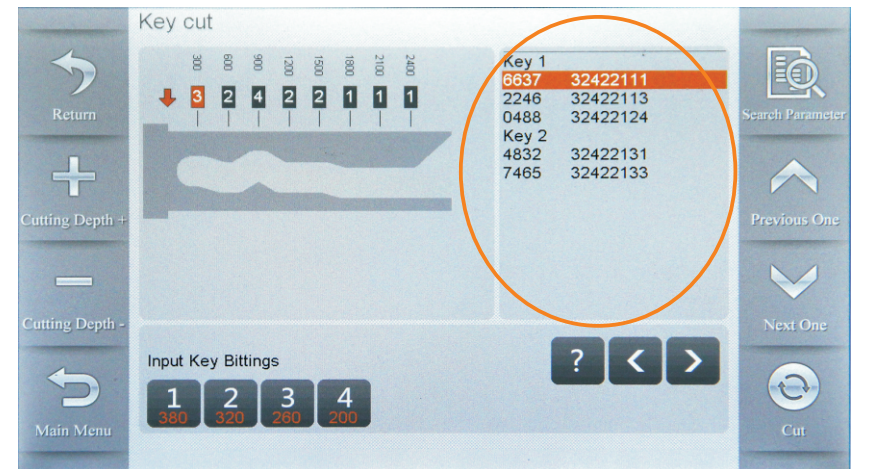

6) Possible key bitting will be listed. Note that system has sorted the codes by the most economical way in order to save blank keys. For example, the bitting under " First key" only needs three blank keys, the bitting under " Second Key" need another three blank keys, then the "third Key"...

7. ONLINE UPDATE

Please contact your dealer/technical support for the driver & latest Update Tool.



Custom Key Tools.exe

1. Connect Mini machine to your PC, turn on the machine.
2. After install "driver file", open the update software.

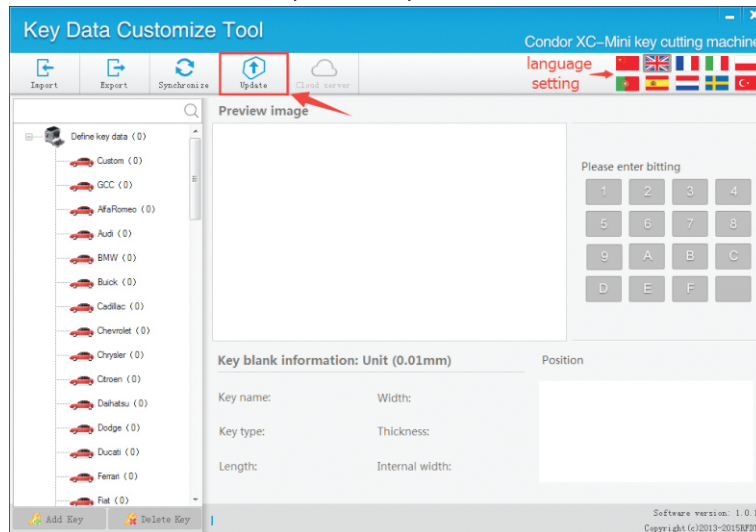

- 1) Select preferred language by yourself, Then click on "Update".

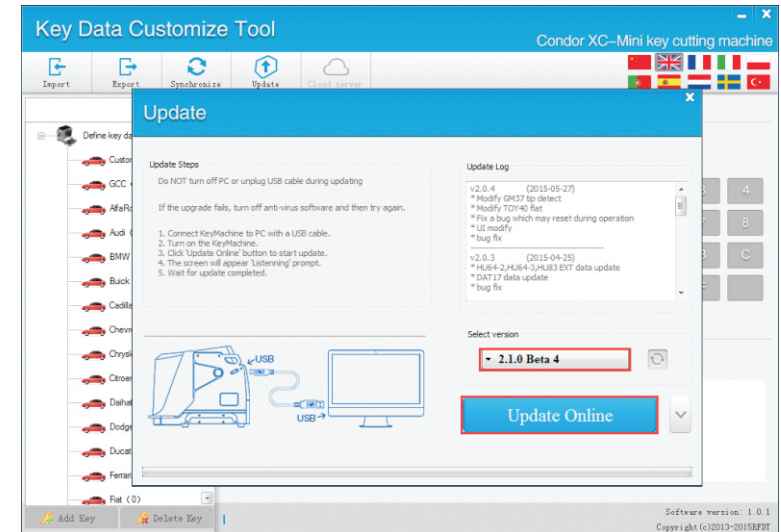

- 2) Select update version, click on "Update Online" wait until display Update Success, wait for a while (30 seconds), Restart machine.

8. HOW TO USE CUSTOMIZE TOOL

Open software, Setting language. (Sample:2015 TOYOTA COROLLA)

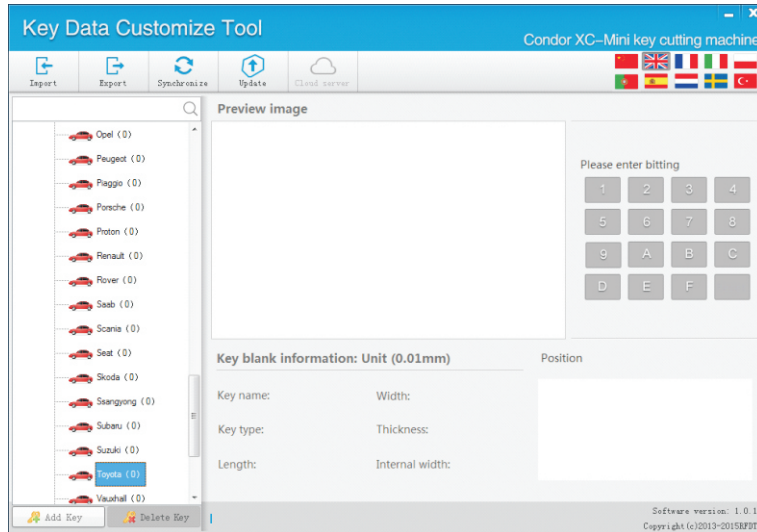

1) Select Brand as the car type list.

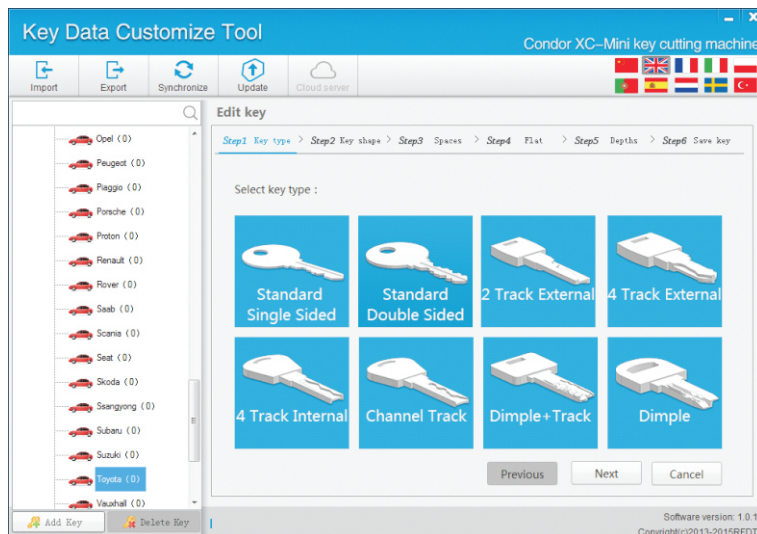

2) Click on "Add Key", then select key type, Then enter all key data (step1 to step 6 do all steps one by one) as the software show you.

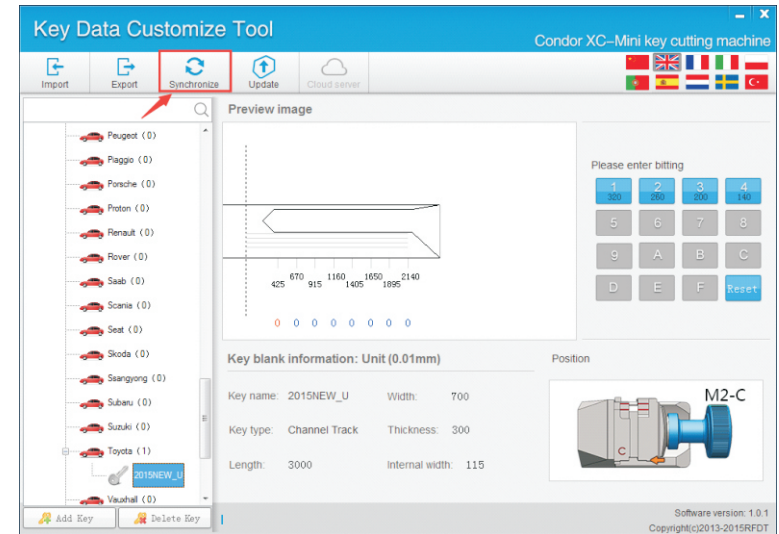

3) Save this key, you can preview the key image.

- Connect Mini machine to PC
- Click on "Synchronize", user can find this customize key in "Key Duplication" & "Cut By Bitting" on the Mini machine.

Notes: user can import/export the customize key as ".u" file, and "Synchronize", then cutting keys.

